

Installation instructions for PZ4AL- 02072-00; PZ4AL- 02073-00

## LEXUS - IS 250 C

Under Run Protective Shield engine bay



Model Year: 2009/04

Vehicle Code: GSE20L-AKTL

Part Number: Steel: PZ4AL- 02072-00

Aluminium: PZ4AL- 02073-00



Weight: Steel: 14.6 kg  
Aluminium: 10.4 kg



InstallationTime: 30 min

Part number: PZ4AL-02072-00; PZ4AL-02073-00

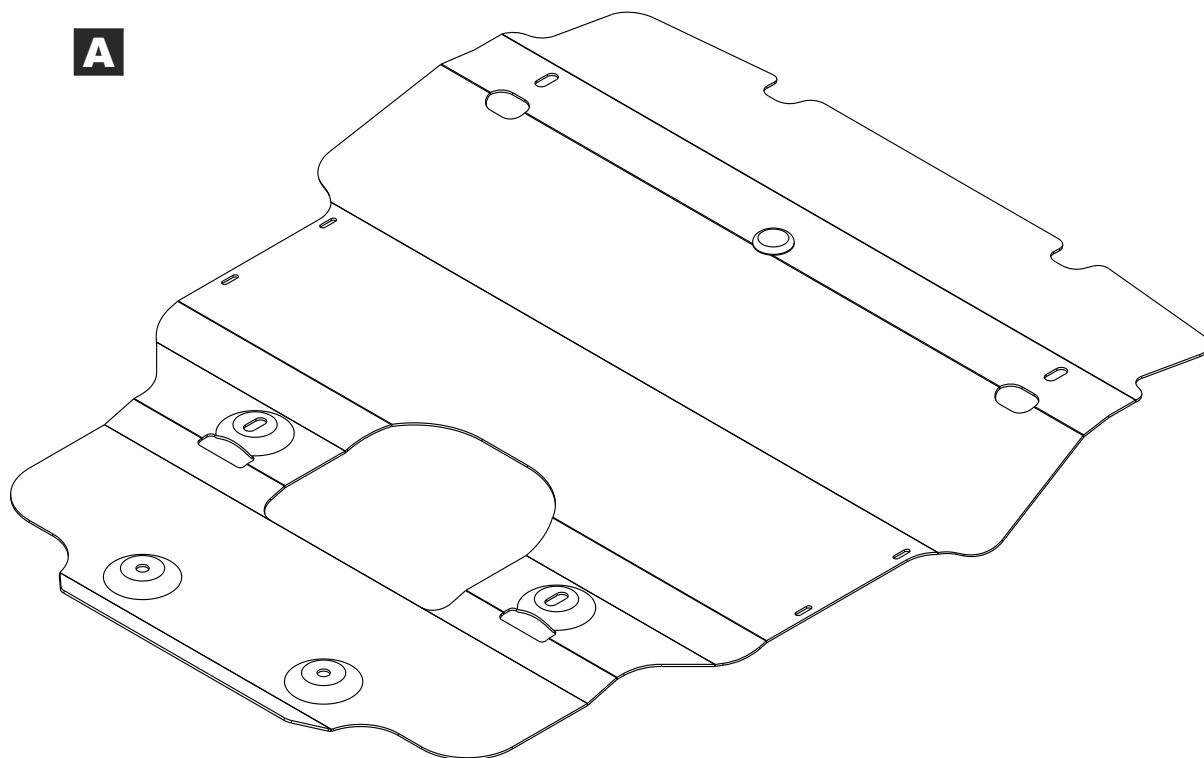

PZ4AL-02072-60

**B**

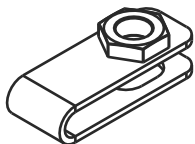

4 x

**C**

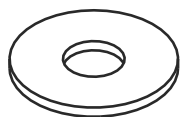

6 x  $\varnothing 10$

**D**



6x M10X30

**I**

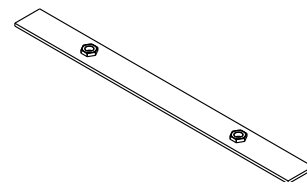

1 x

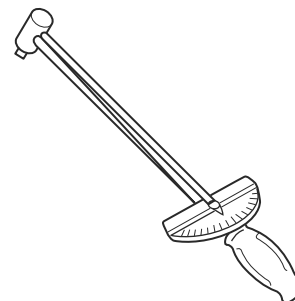
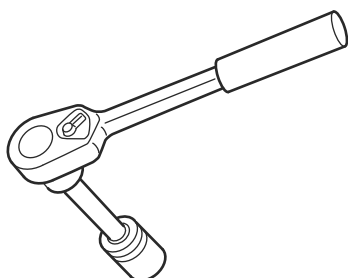

**ATTENTION !**  
Install skid plate for engine bay after skid plate for transmission case is already mounted.

Part number:  
PZ4AL-02072-00  
PZ4AL-02073-00

Issue:  
0

Date:  
06/07/11

Page:  
2/5

1

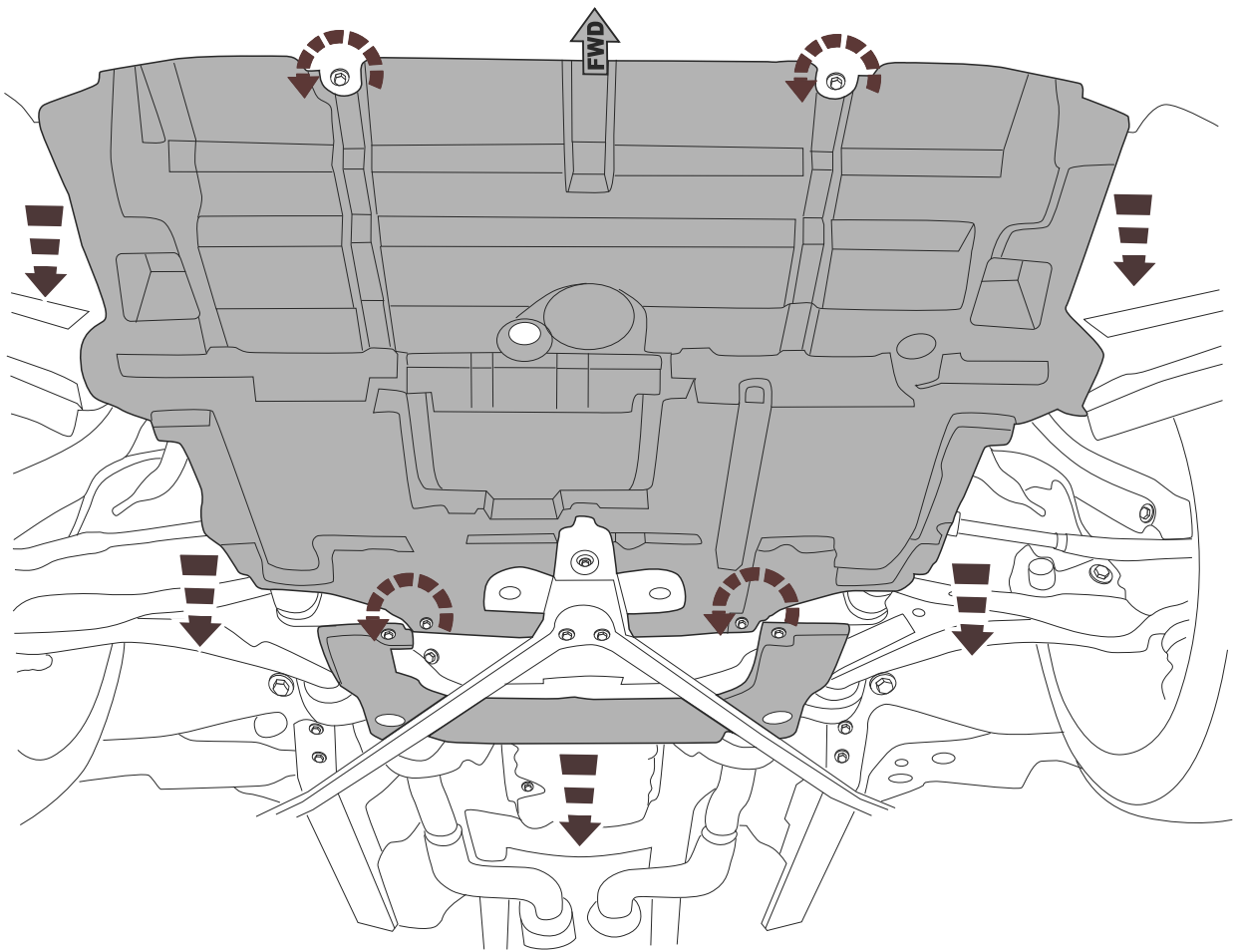

2

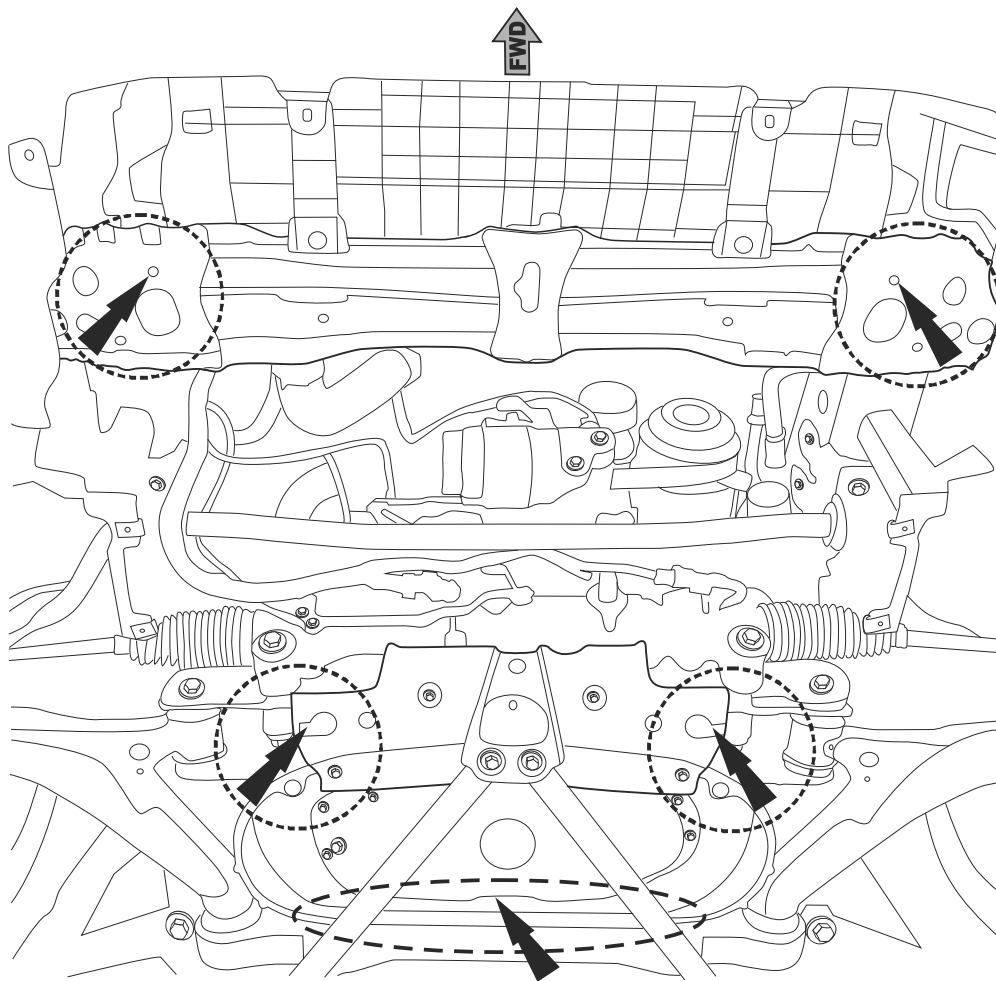

3

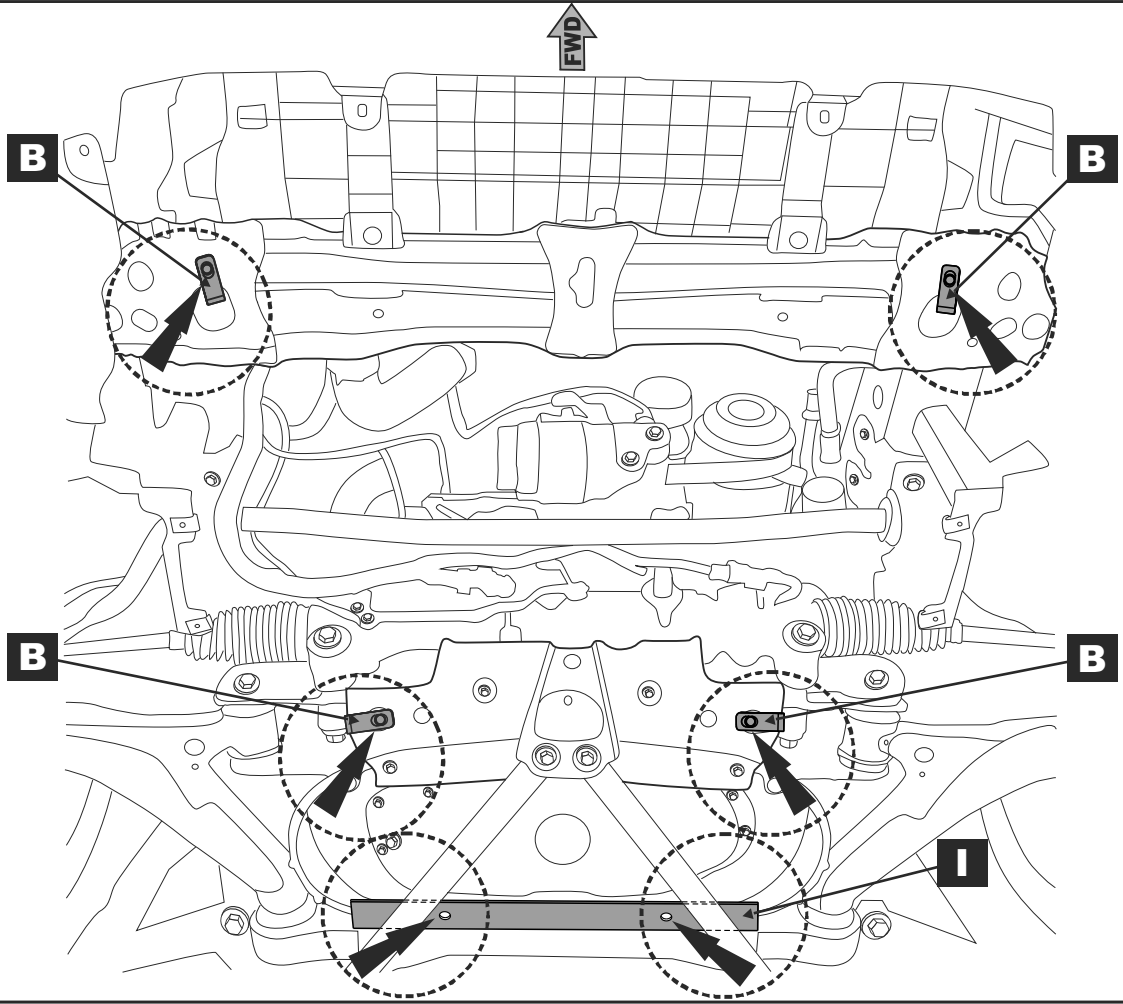

4

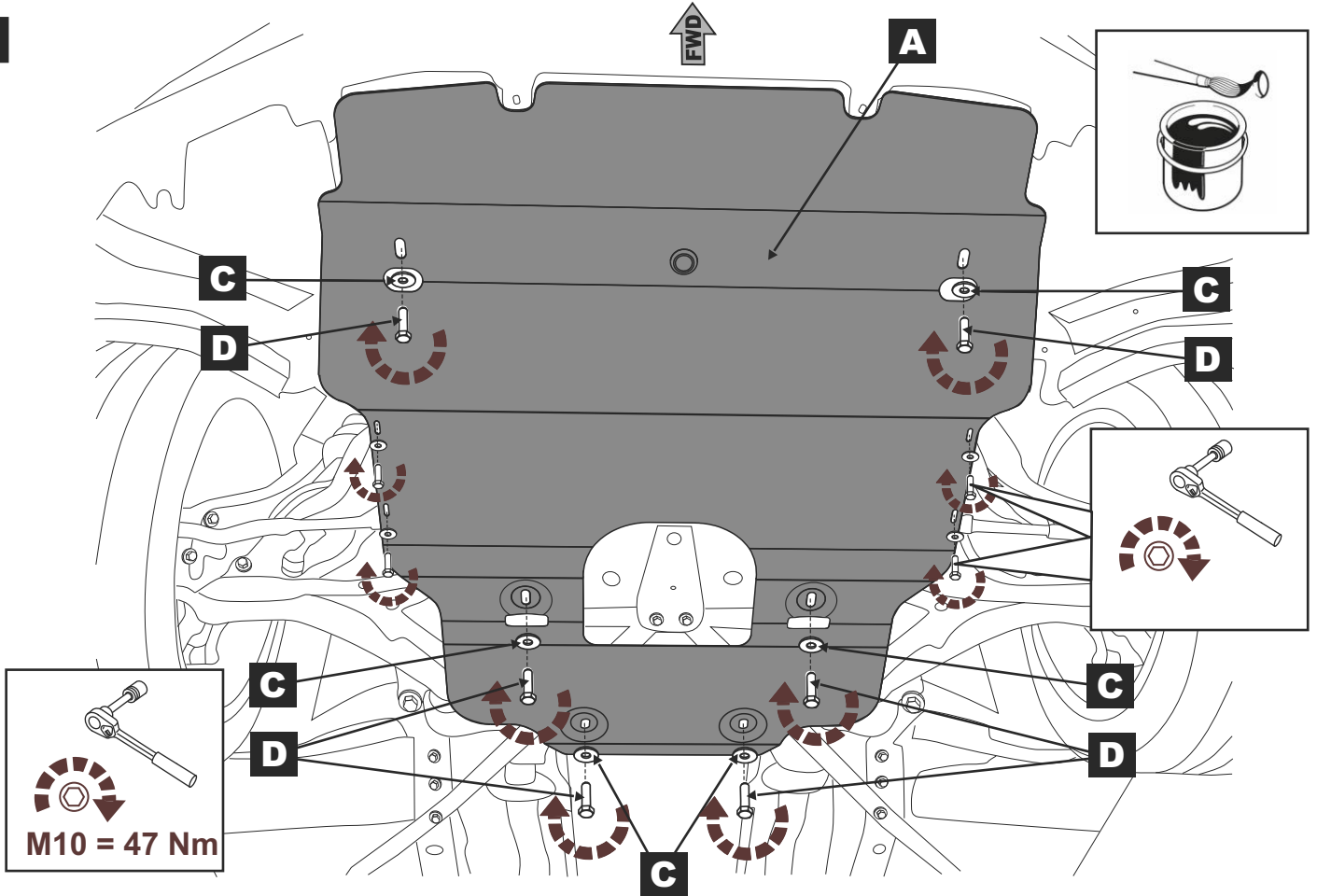

5

